



EPSON TM-T82III 熱感機 安裝手冊

目錄

一、設備介紹	1
二、硬體安裝	1
三、硬體自測	3
四、安裝驅動	4
五、列印紙張大小設定.....	8
六、燈號介紹	8
七、連接口介紹	9



EPSON TM-T82III 熱感機 安裝手冊

一、設備介紹

1. 使用說明書 2.熱感印表機 3.電源線 4.壁掛支架 5.發票檔板 6. USB 傳輸 7.電源開關蓋 8. 80MM 熱感紙
機器有多種放置方式 (臥式、立式、壁掛)。



二、硬體安裝

- 電源插頭在主機後方，要**注意要插好(電源插頭平面朝下)**



電源		電源 必要插上
USB		擇一使用 (附 USB 線)
RS-232		

電源線不可直接拉線向上拔起，需兩隻手指向上推電源線黑殼部分才可拔起（防呆裝置）



- 安裝熱感紙 80MM 可直接安裝，58MM 需安裝檔板

主機上方灰色按鈕向上推，主機上蓋即可向上開啟，開啟後即可放下紙張(須注意方向)

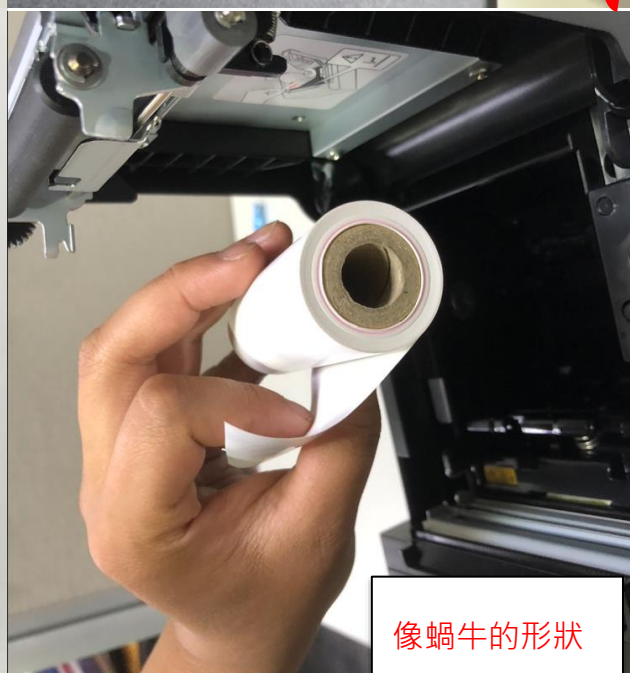

- 紙張正確方向放入後，雙手向下關閉主機上蓋

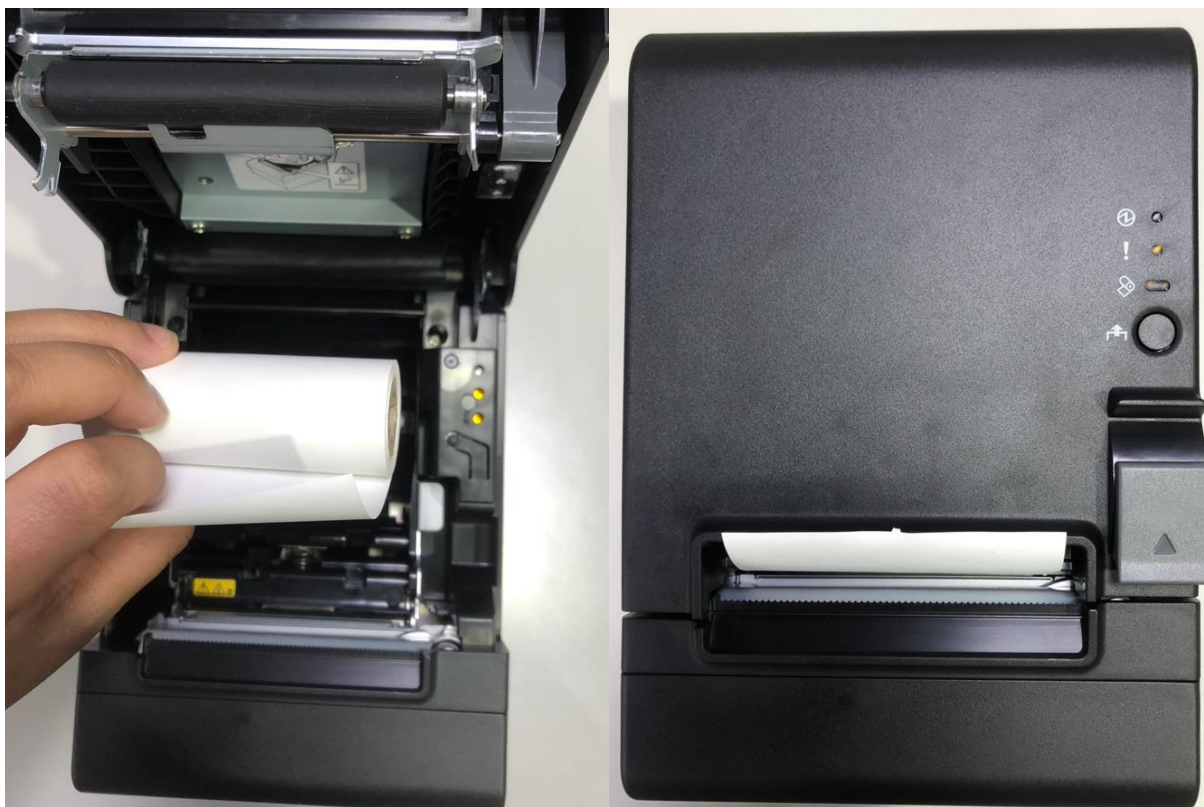

三、硬體自測

硬體版本自測

在關閉發票機的電源情況下，長按機器上的“Feed 鍵” (標示 1.)+開啟電源(標示 2.)，將會印出硬體版本，印出來後可以檢查是否列印清楚及有無斷字。



正常出單	斷字現象
<pre> Printer Name TM-T82III Printer Firmware Version 15.02 ESC/POS Main : 15.02 SERIAL No. X7BJ009452 USB Interface Serial Interface Baud rate : 38400 bps Data bits : 8 bits Parity : none Stop bit : 1 bit or more Handshaking : DTR/DSR Receive error: prints '?' Buffer Capacity 4K bytes Handshaking Operation (busy condition) Offline or receive buffer full Resident Character Alphanumeric Traditional Chinese Automatic Line Feed (CR Command Line Feed) Disable Recovery Point Factory Print Density LIGHT [-3..0..+3] DARK Maintenance Information Thermal Head : 0.000 km Autocutter : 6 cuts Memory Switch 1 1 2 3 4 5 6 7 8 ■■■■■■■■ Memory Switch 5 1 2 3 4 5 6 7 8 ■■■■■■■■ Memory Switch 6 1 2 3 4 5 6 7 8 ■■■■■■■■ Select Modes by pressing Feed button. Continue SELF-TEST: Less than 1 second Mode Selection : 1 second or more </pre>	 <p>自行排除</p> <p>將設備關機 -> 打開機器上蓋</p> <p>-> 清理滾輪及印字頭(用不會掉屑的布，同方向擦拭)</p> <p>◆ 請勿來回擦拭，需單向擦拭</p> <p>#以上無法排除請與微創聯繫(02)-8227-3177 #521 陳小姐</p> <p>微創免付費電話 0809-070-677</p>

● 清理滾輪方式及印字頭

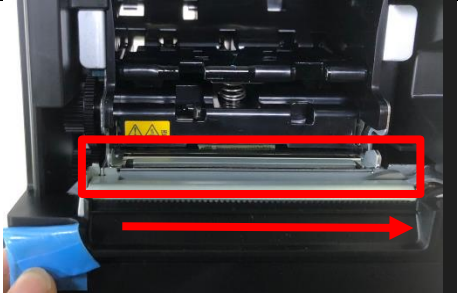
滾輪	印字頭
	
<p>用不會掉屑的布，同方向擦拭，不要左右來回擦</p>	

四、安裝驅動

進入微創公司網站：<http://www.vectronix.com.tw/downloads/?category=driver>

-> 點選 "檔案下載"





EPSON TM-T82III 熱感機 安裝手冊

-> 選單內找尋 “EPSON” -> 點選項目內的 [TM-T82III \(Driver\) Ver.6.04](#) 進行下載驅動



微創系統股份有限公司
Vectronix System Inc.

DATA LOGIC 產品

最新消息

解決方案

服務與支援

檔案下載

網路商城

- 1 USB VCOM Driver (FOR GPS-4400系列/QD-2400系列/支援到WIN10 32 & 64位元)

EPSON

- 1 TM全系列 Driver for vist
- 2 TM全系列 Driver for XP
- 3 TM全系列 CP2102 Wintec Device(USB Driver)
- 4 TM-T82II (Driver)
- 5 TM-T82II Utility
- 6 **TM-T82III (Driver) Ver.6.04**

驅動程式

解壓縮後 -> 會有 9 個檔案 -> 點選執行 APD_604_T82III.exe

名稱	修改日期	類型	大小
APD_604_T82III.exe	2021/5/12 上午 06:04	應用程式	8,969 KB
APD6_Install_en_revC.pdf	2021/5/12 上午 06:04	Microsoft Edge P...	1,961 KB
APD6_Install_sc_revC.pdf	2021/5/12 上午 06:04	Microsoft Edge P...	1,954 KB
APD6_Printer_en_revA.pdf	2021/5/12 上午 06:04	Microsoft Edge P...	4,850 KB
APD6_Printer_sc_revA.pdf	2021/5/12 上午 06:04	Microsoft Edge P...	4,917 KB
APD6_Spec_T82III_en_revA.pdf	2021/5/12 上午 06:04	Microsoft Edge P...	161 KB
APD6_Spec_T82III_sc_revA.pdf	2021/5/12 上午 06:04	Microsoft Edge P...	270 KB
README_EN.TXT	2021/5/12 上午 06:04	文字文件	3 KB
README_SC.TXT	2021/5/12 上午 06:04	文字文件	3 KB

執行畫面

點選 Next -> 選 Agree -> 按下 Install -> 程式會開始跑

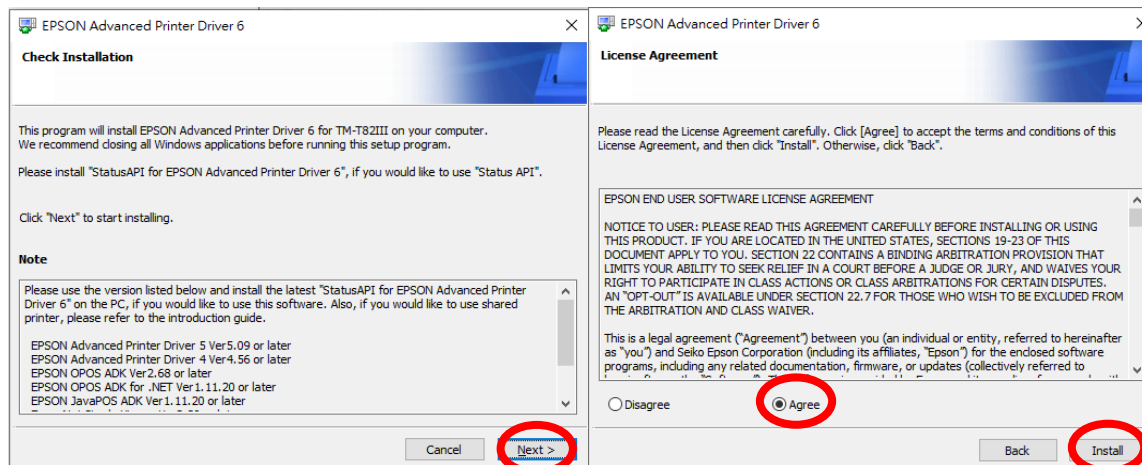



EPSON TM-T82III 熱感機 安裝手冊

EPSON Advanced Printer Driver 6

Installing, please wait.

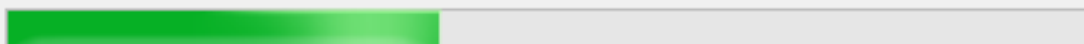

Installing the utility ...

設置 EPSON TM Printer 頁面 -> 選擇印表機 -> 新印表機

The screenshot shows the 'EPSON TM Printer Settings' window with the following sections:

- 1. Select Printer:** A table with columns 'Name', 'Model', and 'Port'. The only entry is '<New Printer>'.
- 2. Printer:** Model is set to 'TM-T82III'. Name is 'EPSON TM-T82III Receipt' with a checked checkbox. A red box highlights the 'Model' and 'Name' fields with the text '框內機型及名稱確認'.
- 3. Communication Settings:** Port Type is 'USB' and Port is 'USB'. A red box highlights this section with the text '選擇連接設備的線材' and a list: 'COM ->RS232', 'Parallel ->LPT1', 'USB ->USB'.
- 4. Apply:** 'Set as Default Printer' is unchecked. A 'Save Settings' button is highlighted with a red box and the text '記得儲存設定'. A 'Test Print' button is also visible.
- 5. Complete:** A 'Close' button is visible.

Attention:
When connecting the customer display to the printer, refer to the EPSON Advanced Printer Driver 6 for DM-D Install Manual.

儲存後進入印表機確認是否有連線成功

設定 -> 裝置 (USB 介面測試)

The screenshot shows the Windows Settings application with the '裝置' (Devices) icon highlighted by a red box. The '裝置' icon is labeled '裝置' and '藍牙、印表機、滑鼠'.

點選印表機與掃描器

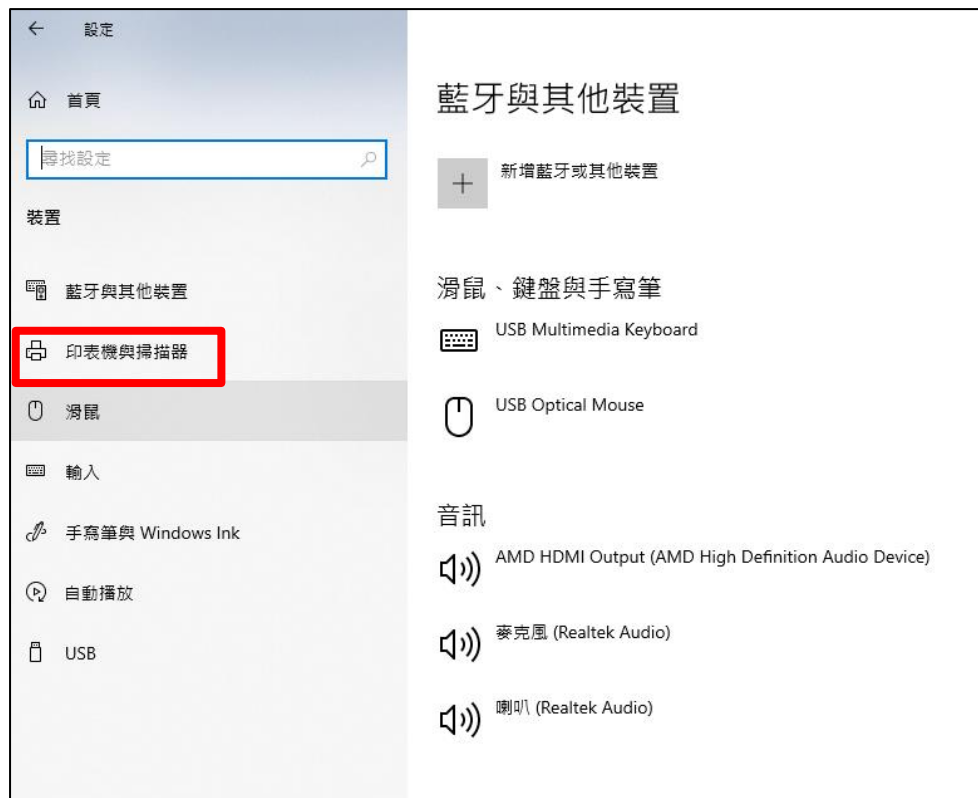

剛剛新增的 EPSON TM-T82III 會出現在印表機列表中

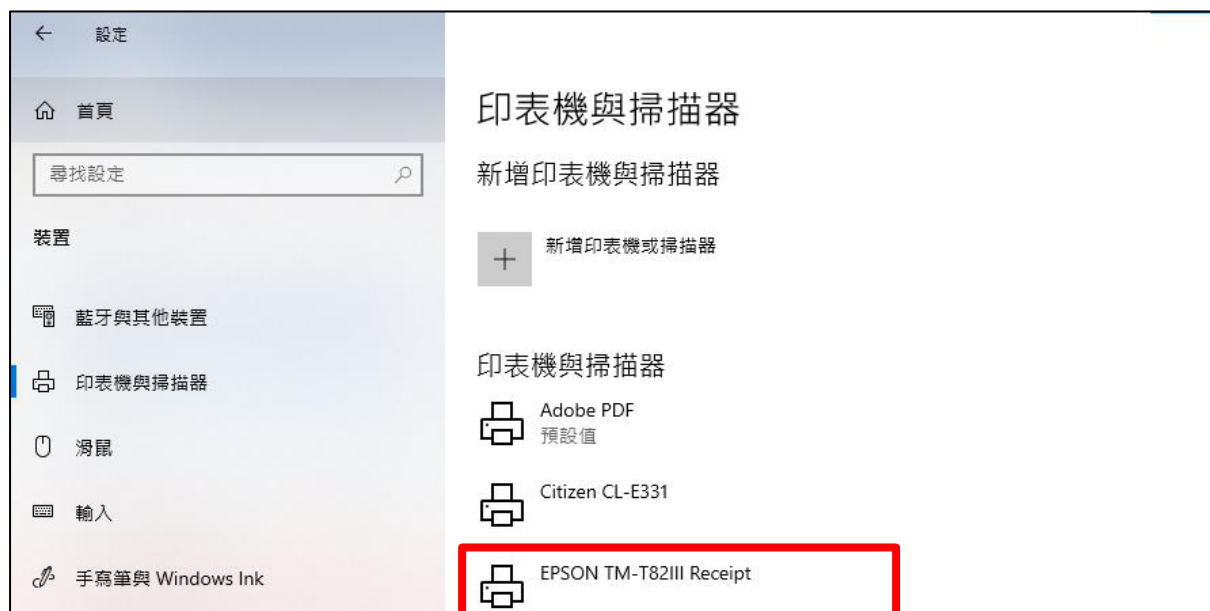



EPSON TM-T82III 熱感機 安裝手冊

點選 TM-T82III -> 管理 -> 列印測試業 ->主機會列印出測試頁(可以印代表有連上)



五、列印紙張大小設定

列印喜好設定 -> 進階 -> 紙張大小 選擇 80*297mm 或 58*297mm

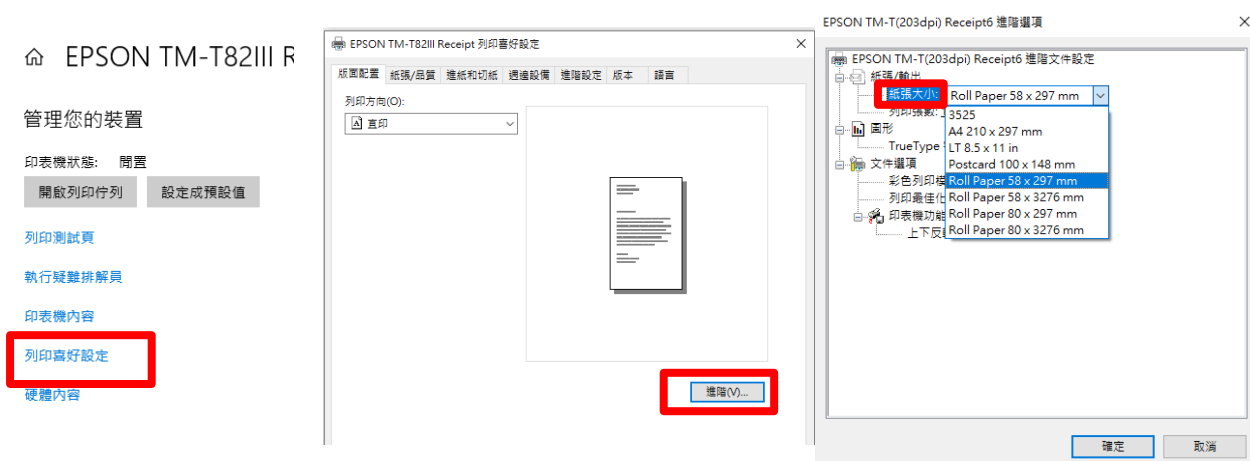

六、燈號介紹

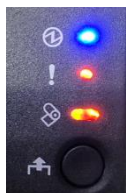
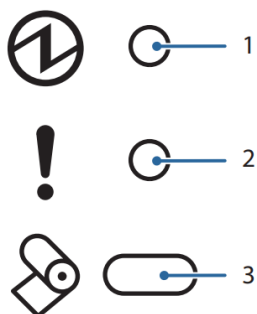

1. 電源打開時亮起，關閉時熄滅
 2. 錯誤時會閃亮或恆亮，偵測到紙張末端時亮燈提醒換紙
 3. 偵測到無紙時亮燈，紙張充足及熄滅，自測正在進行時閃爍
- 三個燈號皆亮為需更換新紙捲示意圖，安裝新紙捲後 2 及 3 燈號熄滅，即可正常使用



七、連接口介紹

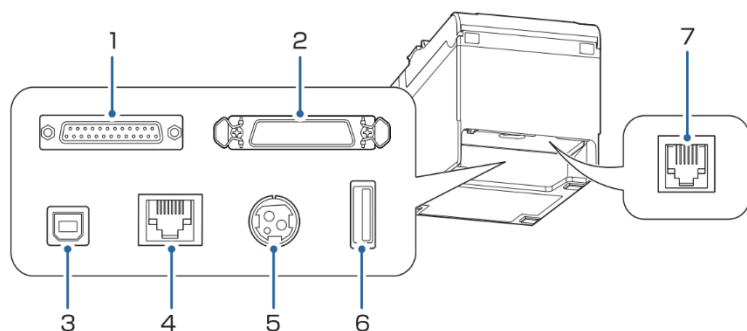

1. 串行接口 · 接電腦 RS232
2. 並行接口 · 接電腦 IEEE1284
3. USB B 型接口
4. RJ45 網路接頭
5. 電源連接口
6. USB A 型接口 · 僅用於連接選購的無線 LAN 版本
7. 連接現金抽屜或可選的外部蜂鳴器